

12-Strand Class II Tuck-Bury End-For-End Splice

The Tuck-Bury splice is designed as a short splice for Class II 12-strand ropes only. Class II ropes are made in whole or part from any of the following high modulus fibers: HMPE, LCP, Aramid and PBO.

Note: This splice is not suitable for Saturn-12 ropes. Follow the modified 12-Strand Class II Tuck-Bury Eye Splice for Saturn-12.

STEP 1 MEASURING AND MARKING

Tape the ends of the ropes to be spliced. Lay Ropes A and B side-by-side and measure 1-1/2 tubular fid lengths, from the taped end of each line and make Mark 1. Tightly tape the rope at Mark 1.

1A From Mark 1, measure 2 fid lengths and make Mark 2 on both ropes.

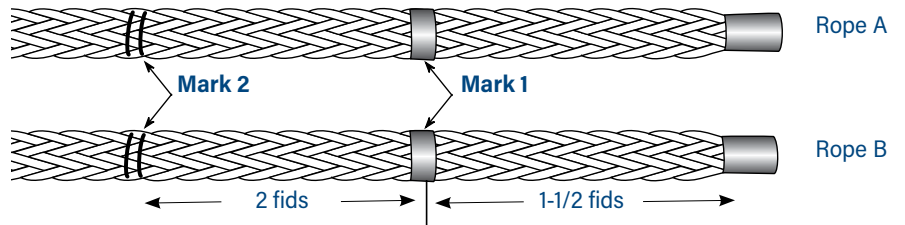

STEP 2 TAPERING THE TAILS

At Mark 1, pull out half the strands (3 "S" and 3 "Z") by rotating around the rope, pulling out strands in the pattern shown:

Z Strands = counter clockwise twist
S Strands = clockwise twist

This should leave 6 strands still braided down the middle. Tightly tape the ends of the 6 individual strands, and the end of the remaining braided portion.

2A On 1 side you should have 2 S and 1 Z and on the other side, 2 Z and 1 S.

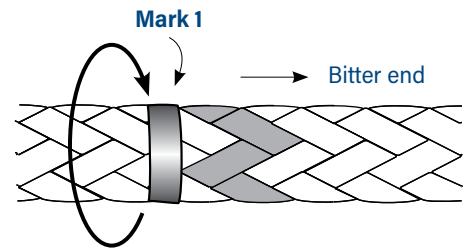

TIP: Tape the ends of the S and Z strands with different tape colors for ease of identification while splicing.

STEP 3 ROUTING THE STRANDS

Reposition the ropes for splicing according to the diagram. Make sure each strand has as little twist as possible.

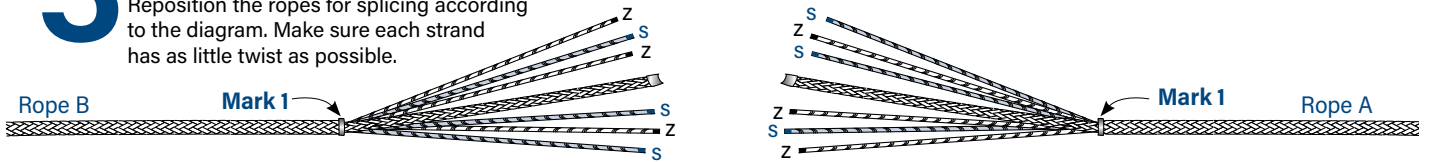

STEP 4 BURYING THE TAIL OF ROPE A INTO ROPE B

From Rope A, pass the 3 closest strands to Rope B through Rope B, 1 or 2 picks down from Mark 1. Do not pull strands all the way through at this stage. The strands enter at the entry point 2 picks from Mark 1, and exit at the exit points 2 picks from the entry point.

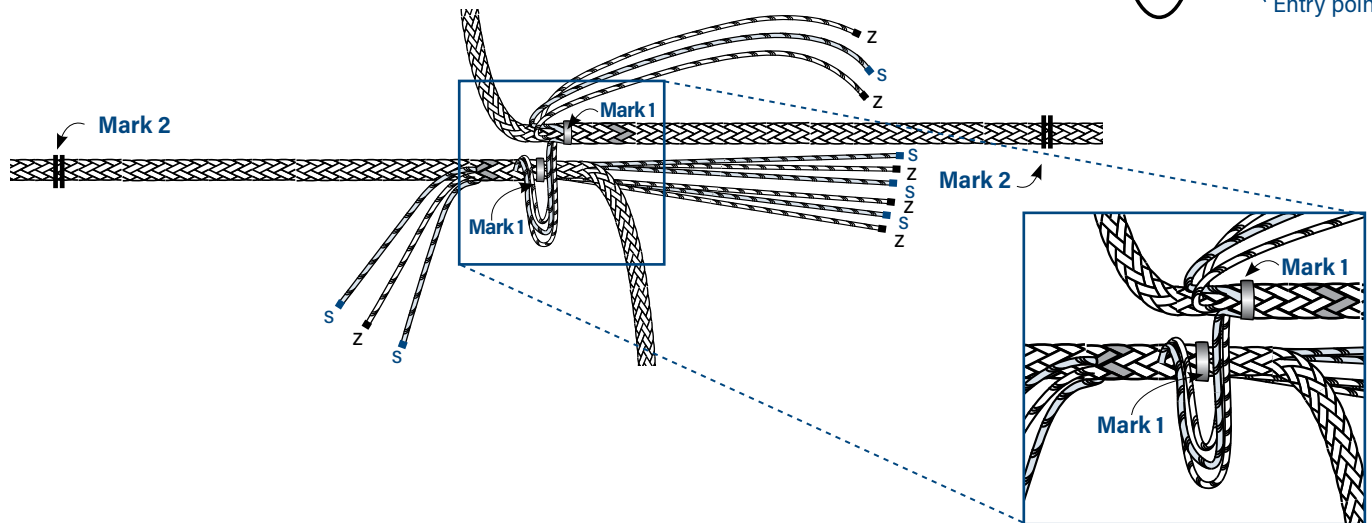
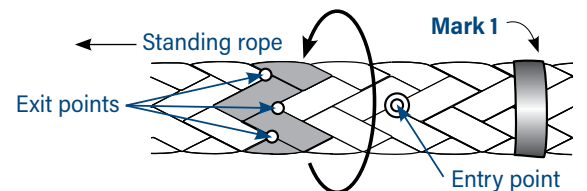



12-Strand Class II Tuck-Bury End-For-End Splice

4A Bury the remaining braided strands down the center of the rope, entering at Mark 1 and exiting at Mark 2. The tail should enter the standing part of the rope at the same point where the 3 loose strands passed through. Pull the tail out at Mark 2.

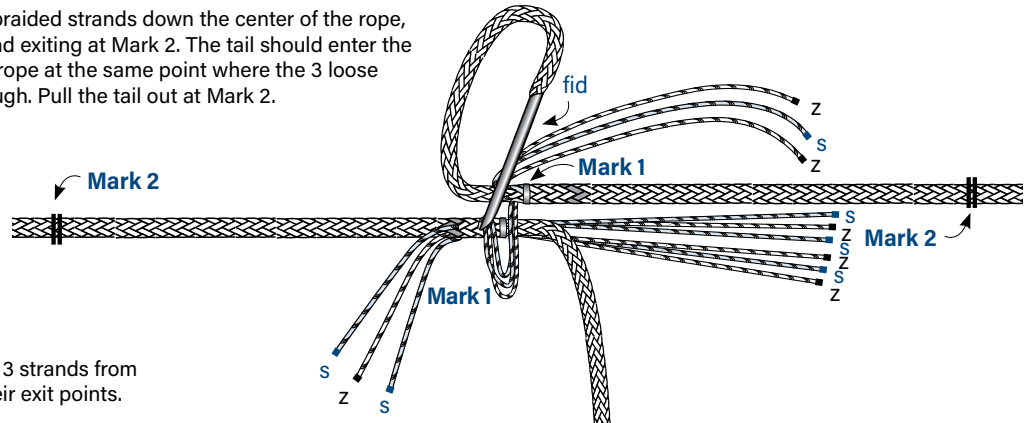

4B Route the remaining 3 strands from the entry point to their exit points.

Repeat Steps 4, 4A, and 4B on the opposite end of the rope.

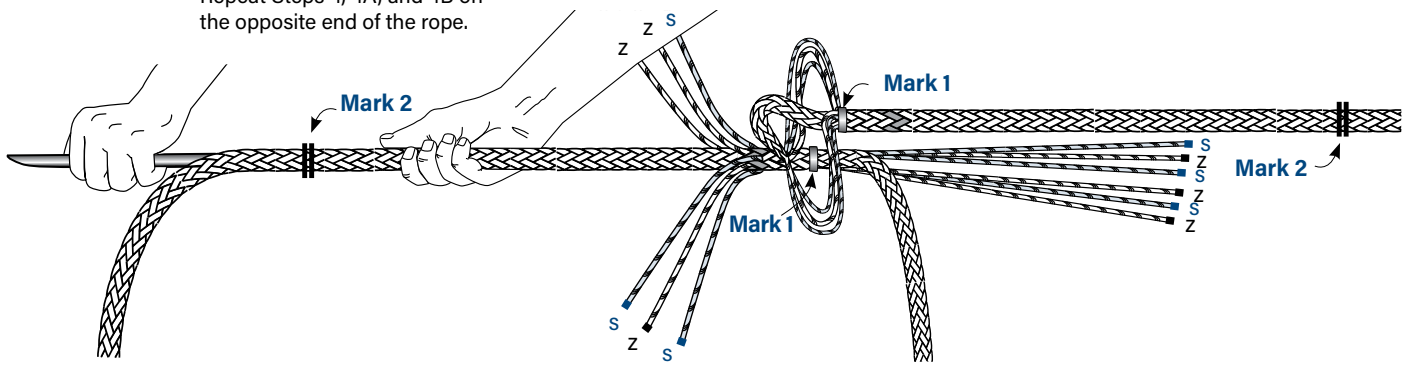

STEP 5 TAPERING THE TAILS

At the end of the tapered tail, remove the fid and any tape at the end of the tail. From the end of the tail, mark 3 consecutive strands, as shown. Pull them out of the braid and cut off close to the body of the rope.

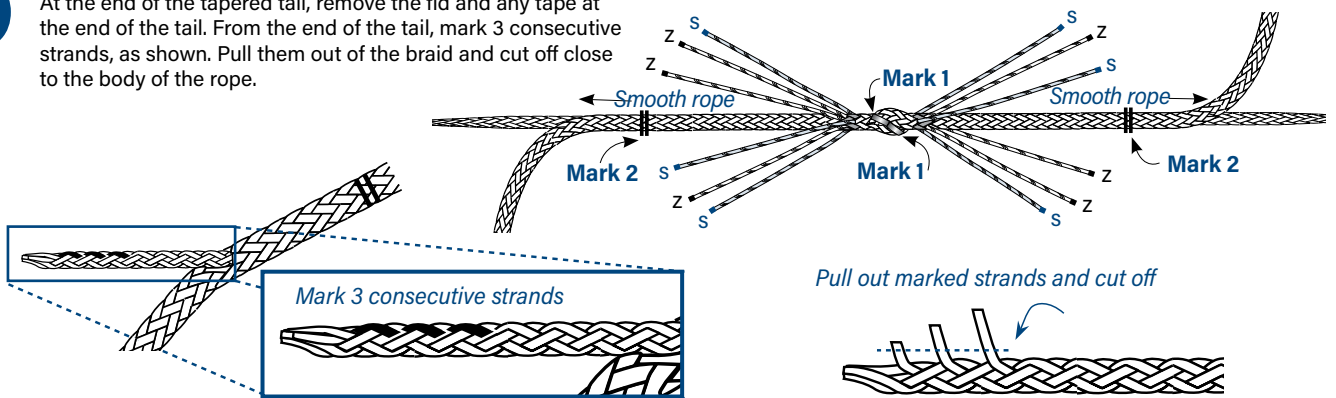

5A Remove the tape from the end of the tails. Now smooth the rope from the crossover toward Mark 2 to bury the tails.

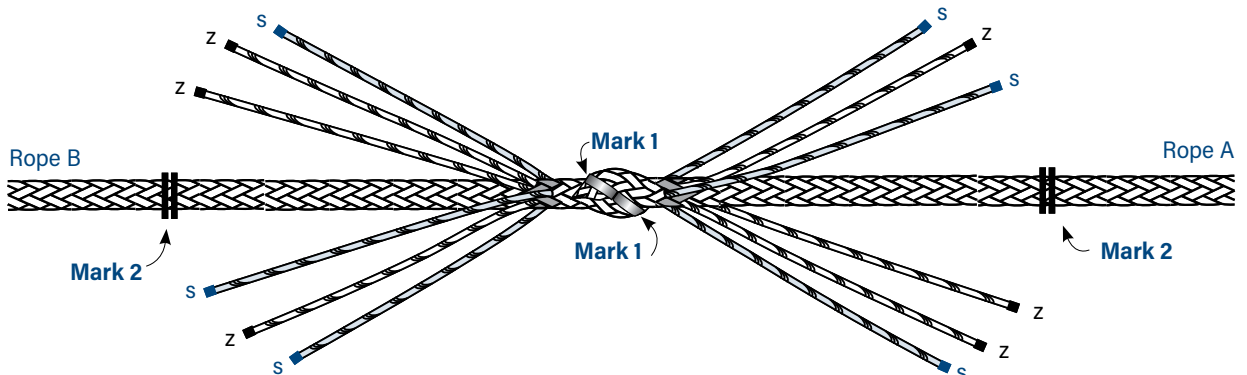

12-Strand Class II Tuck-Bury End-For-End Splice

STEP 6 TUCKING THE STRANDS

Tuck the strands from Rope A into Rope B. 1 complete tuck consists of passing a strand over 1 strand and under 2 strands.

Do 3 complete tucks for all 6 strands. Each strand is always tucked under the same line of the braid so that the tucks progress straight down the body of the rope.

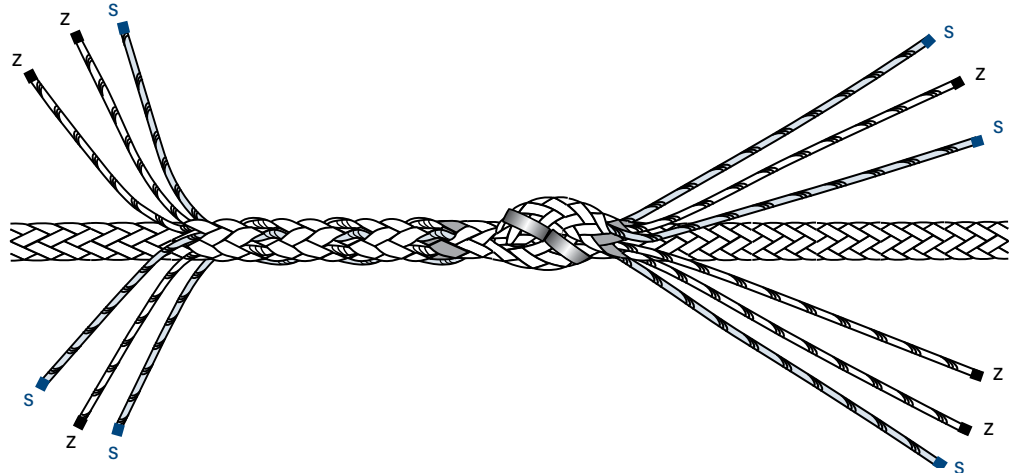

6A

After completing the first 3 tucks, remove half the volume of the twisted yarns from each of the 6 strands near the taped ends, and complete 3 more tucks with the reduced-volume strands.

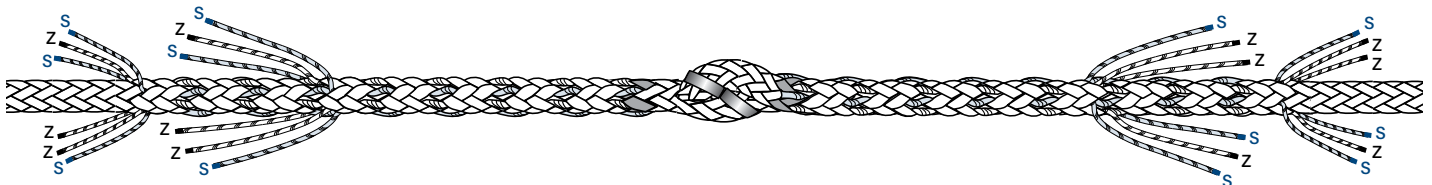

STEP 7 GROUPING THE STRANDS

Group tail strand pairs with closest exiting point into 6 separate groups. There will be 12 groups total, 6 on each side of the splice.

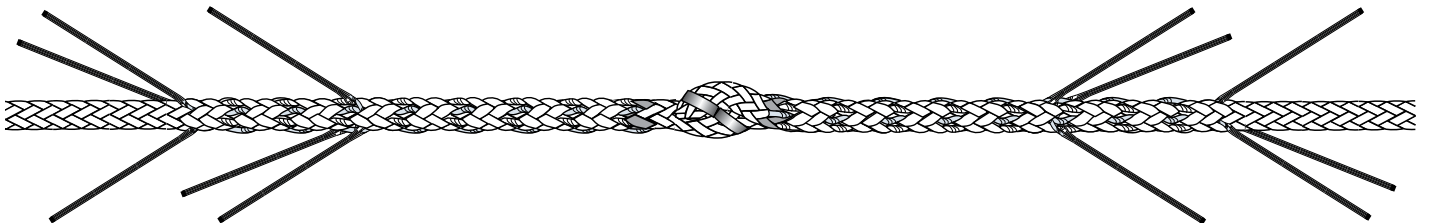

12-Strand Class II Tuck-Bury End-For-End Splice



STEP **8** **TUCKING PROCEDURE**

Tuck previously grouped tail under 2 picks.

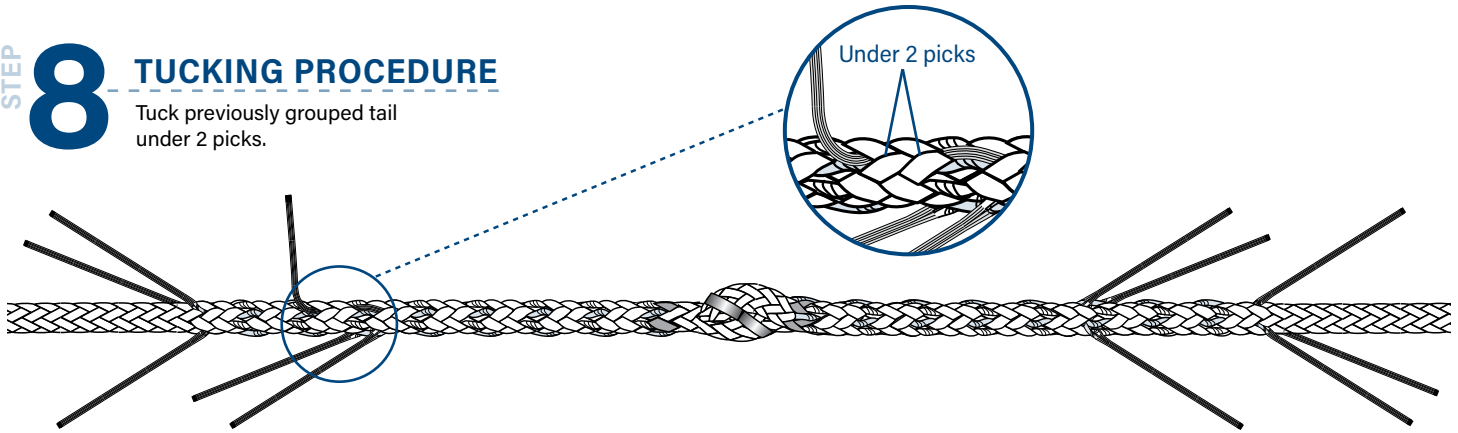

8A Pass tail through to the other side, passing through the center of the rope.

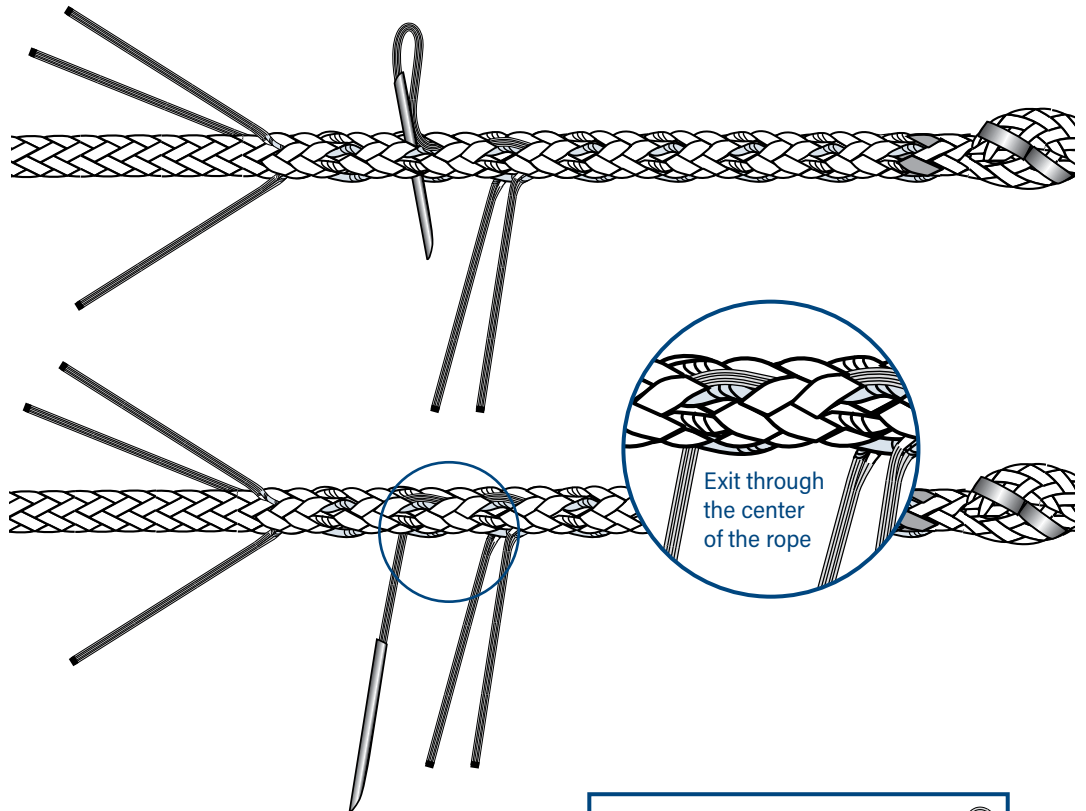

8B Flip the rope over and pass tail under 3 picks, exit, and pull snug.

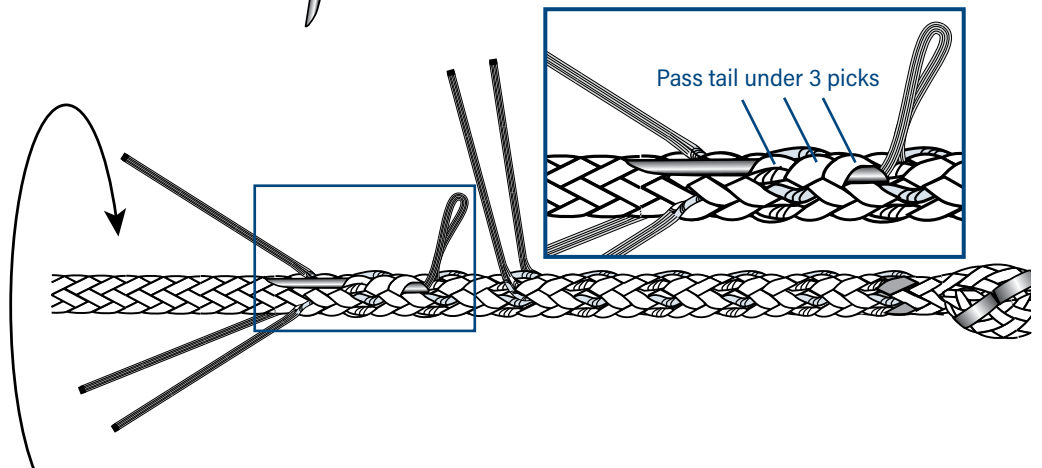

12-Strand Class II Tuck-Bury End-For-End Splice



8C Cut the excess strands flush with rope. **Be careful not to cut the body of the main rope.**

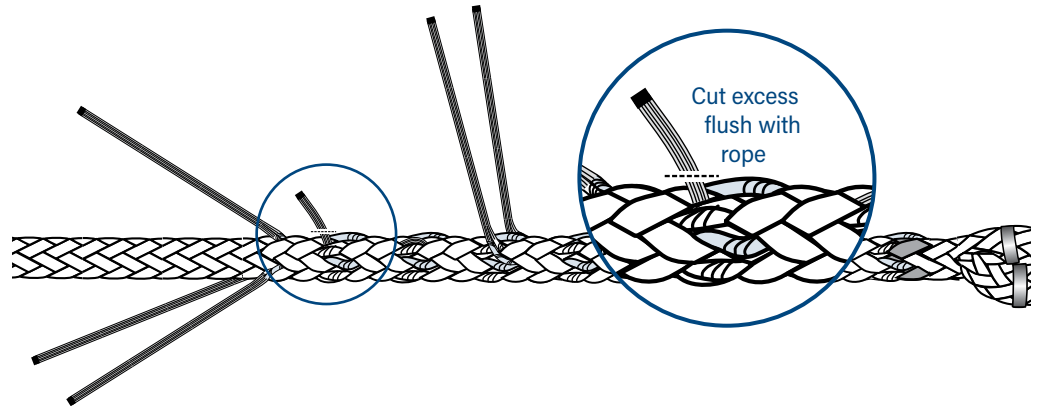

STEP 9 FINISHING THE SPLICE

Your finished Tuck-Bury End-for-End Splice will look like this:



Finished splice